

**KOSTRZEWA®**  
Lider kotłów na pelet



## Instrukcja montażu zbiornika 290L

*Installation manual of the tank 290L*



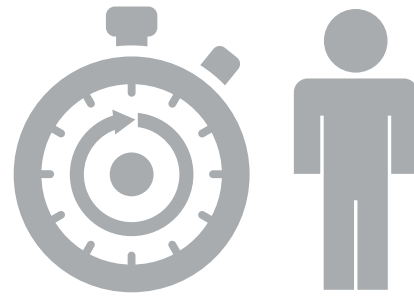
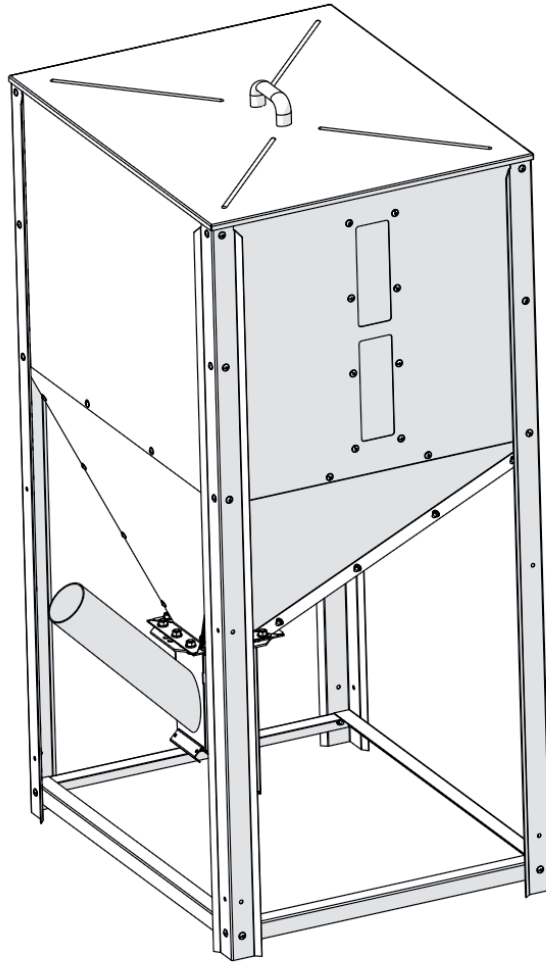

60 min

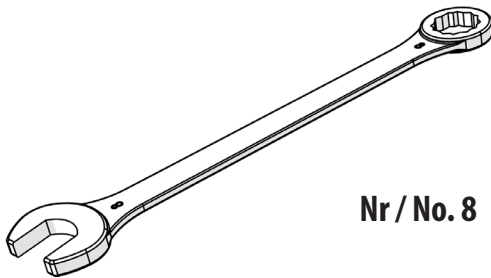

Nr / No. 8

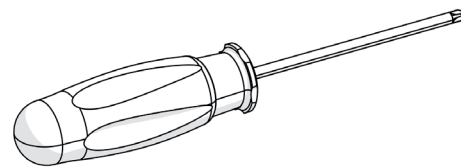

SL/PZ2

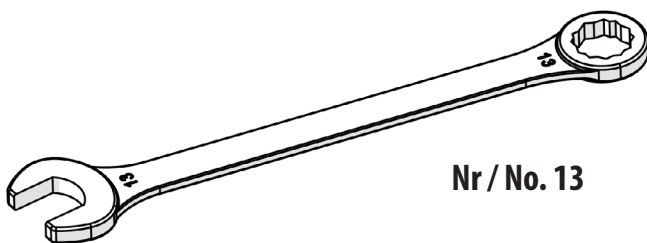

Nr / No. 13

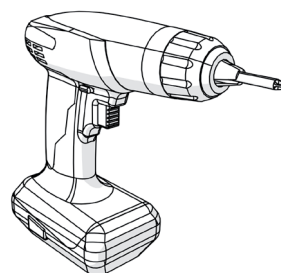

SL/PZ2

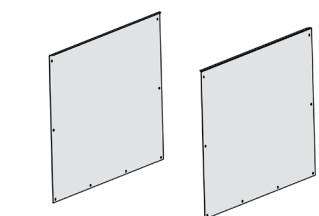
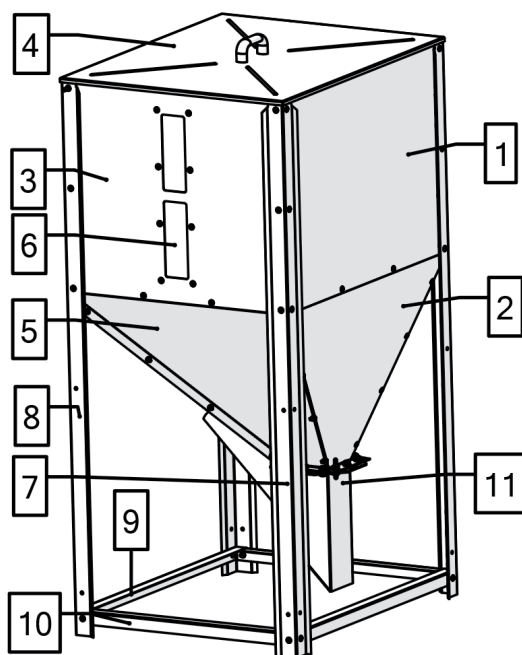

**Nr / No. 1**  
1 szt. (L+P) / pc

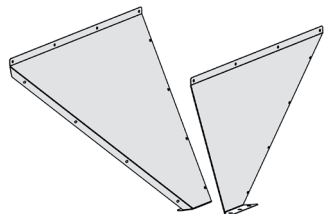

**Nr / No. 2**  
1 szt. (L+P) / pc

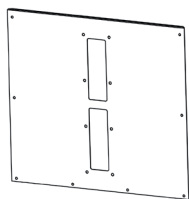

**Nr / No. 3**  
1 szt. / pc

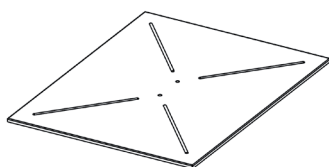

**Nr / No. 4**  
1 szt. / pc

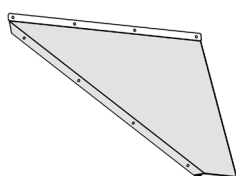

**Nr / No. 5**  
1 szt. / pc



**Nr / No. 6**  
1 szt. / pc

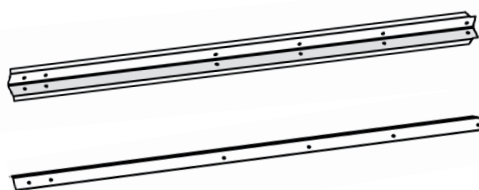

**Nr / No. 7**  
2 szt. / pcs

**Nr / No. 8**  
2 szt. / pcs

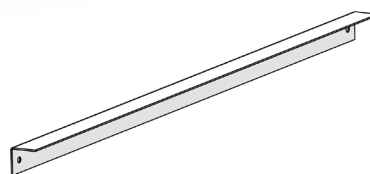

**Nr / No. 9**  
2 szt. / pcs



**Nr / No. 10**  
2 szt. / pcs

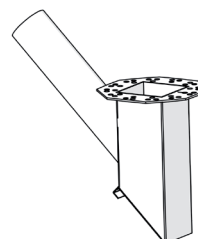

**Nr / No. 11**  
1 szt. / pc

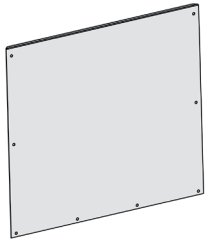
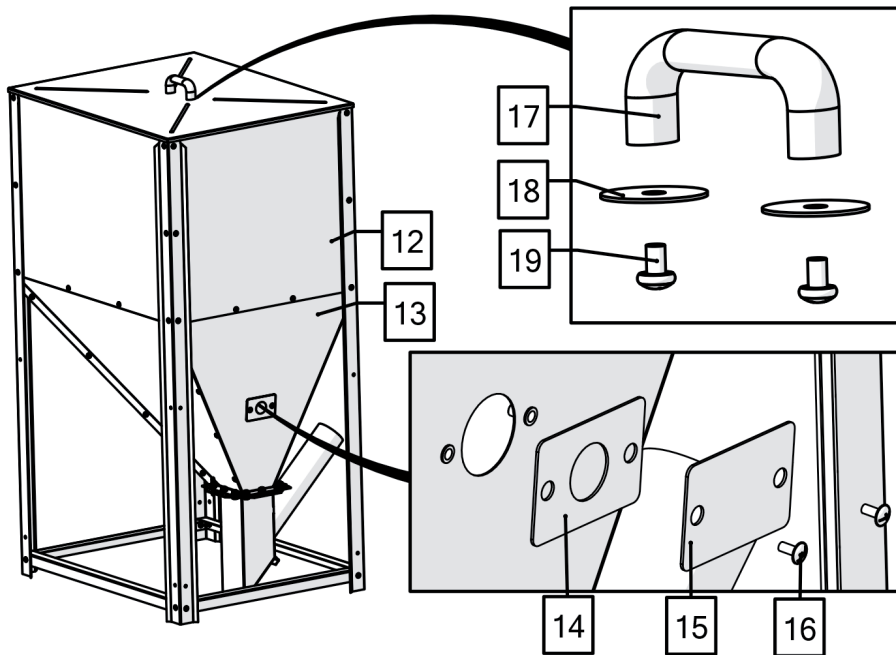

**Nr / No. 12**  
1 szt. / pc

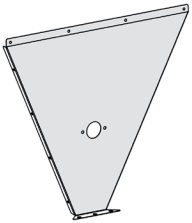

**Nr / No. 13**  
1 szt. / pc

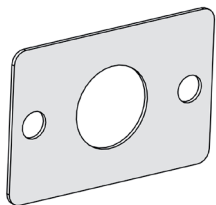

**Nr / No. 14**  
1 szt. / pc

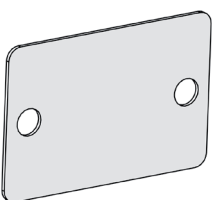

**Nr / No. 15**  
1 szt. / pc

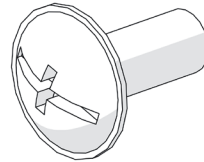

**Nr / No. 16**  
66 szt. / pcs

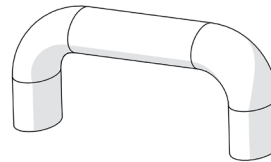

**Nr / No. 17**  
1 szt. / pc

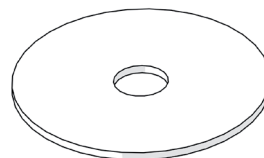

**Nr / No. 18**  
2 szt. / pcs

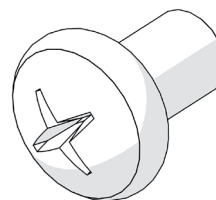

**Nr / No. 19**  
2 szt. / pcs

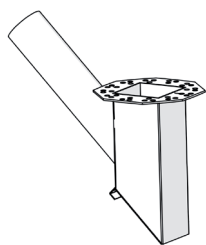
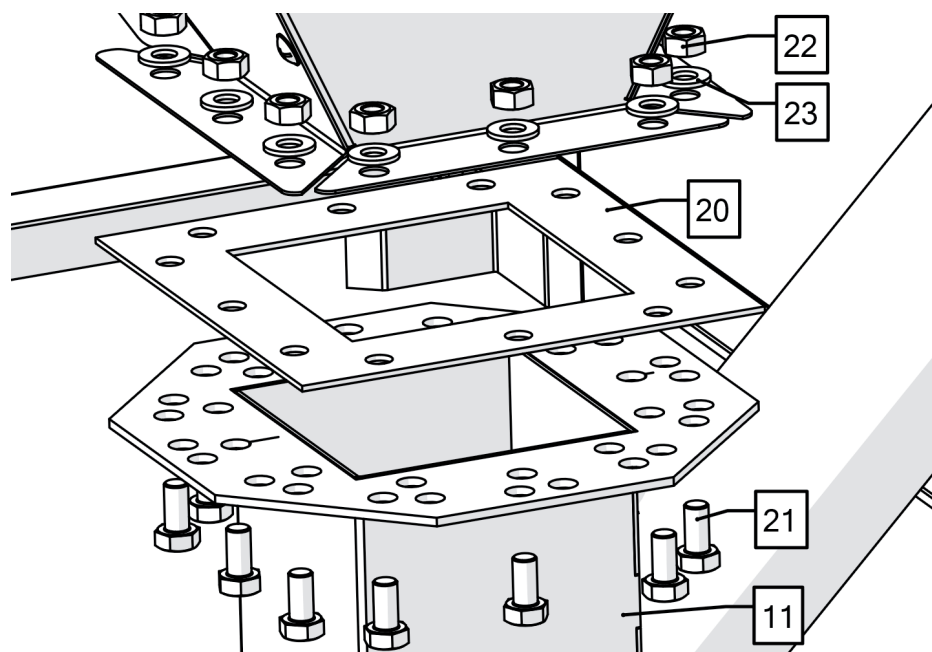
**Nr / No. 11**

1 szt. / pc

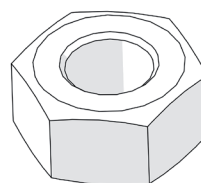
**Nr / No. 22**

12 szt. / pcs

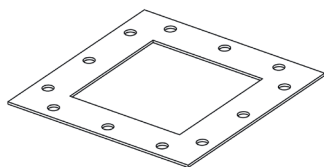
**Nr / No. 20**

1 szt. / pc

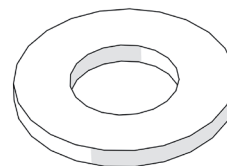
**Nr / No. 23**

12 szt. / pcs

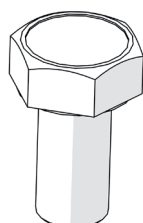
**Nr / No. 21**

12 szt. / pcs

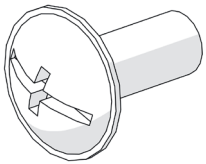
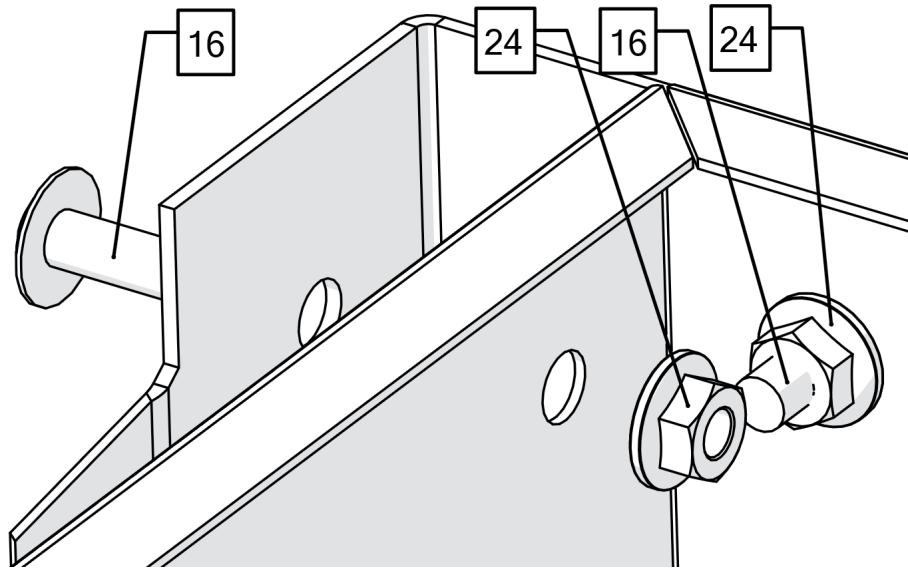

**Nr / No. 16**  
66 szt. / pcs

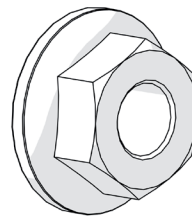

**Nr / No. 24**  
64 szt. / pcs



**KOSTRZEWA<sup>®</sup>**  
Lider kotłów na pelet



Kraina Wielkich  
Jezior  
Mazurskich  
The Great Masurian Lake district

## Kontakt | Contact us

P.P.H. Kostrzewa Sp.J.

11-500 Giżycko  
ul. Przemysłowa 1  
Polska / Poland

tel. / phone: +48 87 429 56 00

tel. / phone: +48 87 428 53 51

fax : +48 87 428 31 75

[www.kostrzewa.com.pl](http://www.kostrzewa.com.pl)